

Random Stop Series
随意停系列

Random Stop Series
随意停系列

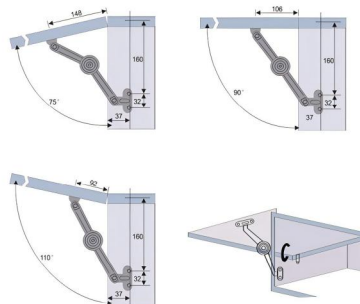

SYT-01
厚装细纹随意停
Thick and fine lines stop at will

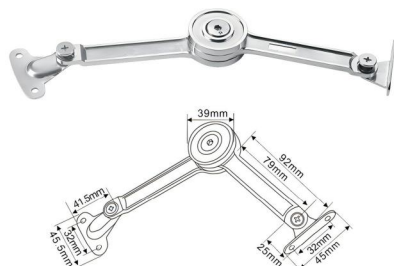

SYT-02
薄装细纹随意停
Thin clothes and fine lines stop at will

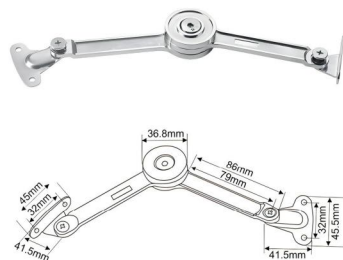

SYT-03A
刀型随意停 (大号)
Knife type free stop (large)

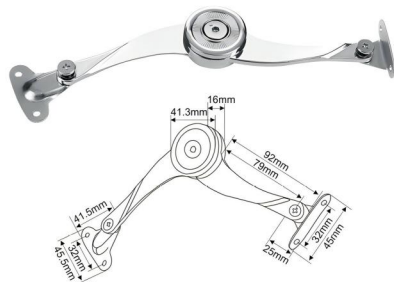

SYT-03B
刀型随意停 (小号)
Knife type random stop (small)

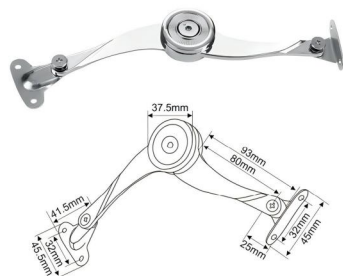

SYT-04
标准装粗纹随意停
Standard Pack Coarse Texture Random Stop



SYT-05A
厚装粗纹随意停
Thick and rough texture stop at will



SYT-05B
薄装 360° (带刹) 随意停
Thin 360° (with brake) random stop

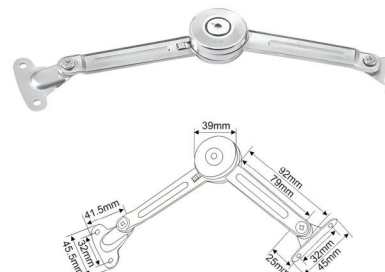

SYT-06
特厚装粗纹随意停
Extra thick thick grain free stop

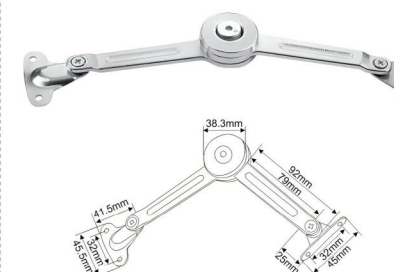

SYT-07
特厚 360° (带刹) 随意停
Extra thick 360° (with brake) random stop

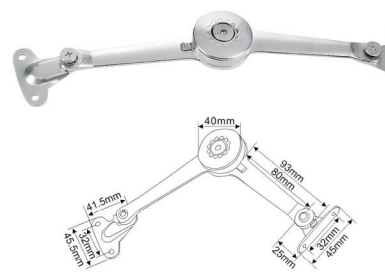

使用特点 Use feature

1. 使用橱柜的上翻木门和铝框门
2. 开启角度：通过改变安装尺寸，上翻门最大开启角度可调整在 75°、90°、105° 位置
3. 上翻门在开启到最大开启度可停住，其它任意位置为随意停状态及门板在任意位置可以停住。
4. 调整重新六角螺丝可承受不同重量的门板，达到最佳效果。

1. Use the upturned wooden door and aluminum frame door of the cabinet
2. Opening angle: By changing the installation size, the maximum opening angle of the upturning door can be adjusted at 75°, 90°, and 105° positions
3. The upturning door can be stopped when it is opened to the maximum opening degree, while other arbitrary positions can be stopped at will and the door panel can be stopped at any position.
4. Adjust the new hexagon screws to withstand different weight of the door panel to achieve the best effect.

Random Stop Series
随意停系列

Heavy Cabinet Door Support Series
重型柜门支撑系列



SYT-08A
圆杆油压支撑
Round rod hydraulic support



SYT-18
重型支撑
Heavy support



SYT-08B
扁杆油压支撑
Flat rod hydraulic support



SYT-08C
扁杆油压支撑
Flat rod hydraulic support



SYT-19
重型支撑
Heavy support



SYT-09
加强型随意停
Enhanced random stop

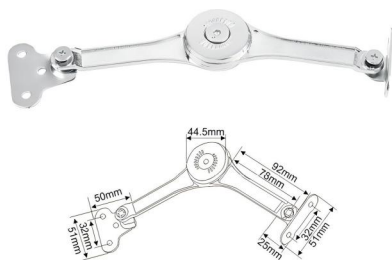

SYT-11
法拉款随意停
Farah style stop at will



SYT-21
重型柜门机械支撑
Mechanical support for heavy cabinet doors



Hinge Series
合页系列

Damping Support/Bracket/Cabinet, Chair Leg Series
阻尼支撑 / 支架 / 柜、椅脚系列

HY-01
天地合页
Heaven and earth hinge



HY-06
梳妆台随意停合页
Free stop hinge for dressing table



SYT-41
阻尼支撑 (长柄)
Damping support (long handle)



SYT-42
阻尼支撑 (短柄)
Damping support (short handle)



HY-07
梳妆台缓冲合页
Dressing table cushion hinge



HY-08
梳妆台缓冲合页
Dressing table cushion hinge



ZJ-01
悬浮支架
Dressing table cushion hinge



HY-16
柜门合页
Cabinet door hinge



JJJ-01
铝沙发脚
Aluminum sofa legs



JJJ-06
可调柜脚
Adjustable cabinet feet



Breathable Mesh Series
透气网系列

TQW-42

三孔铝合金透气网 (4.2CM 宽)
Three-hole aluminum alloy breathable mesh (4.2CM wide)

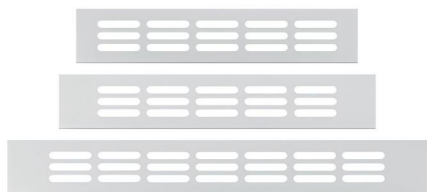

开孔尺寸
宽度: 32mm
长度: 总长减 20mm

TQW-50

五孔铝合金透气网 (5cm 宽)
Five-hole aluminum alloy breathable mesh (5cm wide)

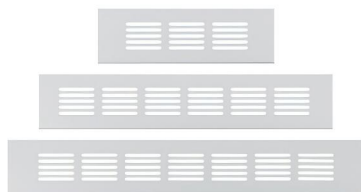

开孔尺寸
宽度: 35mm
长度: 总长减 30mm

TQW-80

九孔铝合金透气网 (8cm 宽)
9-hole aluminum alloy breathable mesh (8cm wide)

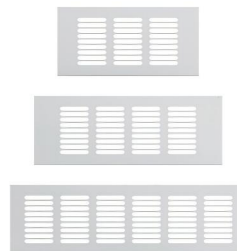

开孔尺寸
宽度: 64/67mm
长度: 总长减 30mm

TQW-90

九孔铝合金透气网 (9cm 宽)
9-hole aluminum alloy breathable mesh (9cm wide)

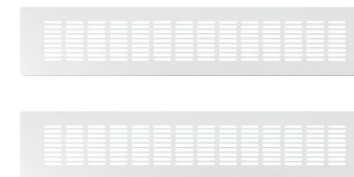

开孔尺寸
宽度: 64mm
长度: 总长减 30mm

TQW-60

六孔铝合金透气网 (6cm 宽)
Six-hole aluminum alloy breathable mesh (6cm wide)



开孔尺寸
宽度: 46mm
长度: 总长减 30mm

TQW-70

六孔错位铝合金透气网 (7CM 宽)
Six-hole staggered aluminum alloy breathable mesh (7CM wide)

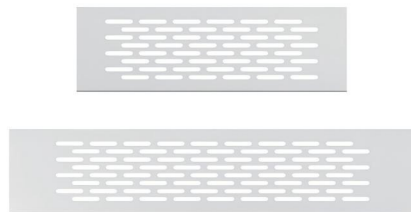

开孔尺寸
宽度: 59mm
长度: 总长减 30mm

TQW-100

十二孔铝合金透气网 (10cm 宽)
Twelve hole aluminum alloy breathable mesh (10cm wide)

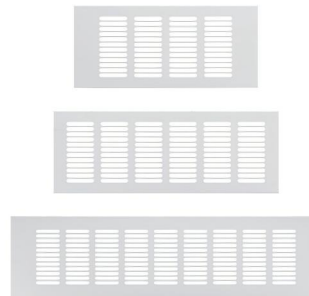

开孔尺寸
宽度: 88mm
长度: 总长减 30mm

TQW-120

十二孔铝合金透气网 (12cm 宽)
Twelve hole aluminum alloy breathable mesh (12cm wide)



开孔尺寸
宽度: 97mm
长度: 总长减 30mm

Breathable Mesh Series
透气网系列

TQW-150

十孔铝合金透气网 (15cm 宽)
Ten hole aluminum alloy breathable mesh (15cm wide)

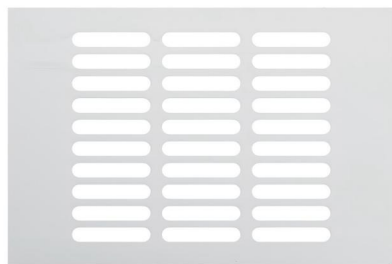

开孔尺寸
宽度: 138mm
长度: 总长减 30mm

TQW-200

十二孔铝合金透气网 (20cm 宽)
Twelve hole aluminum alloy breathable mesh (20cm wide)

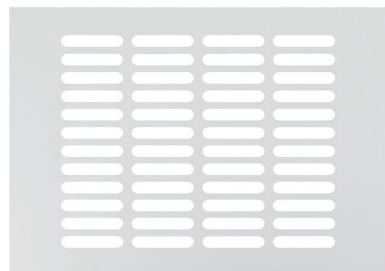

开孔尺寸
宽度: 181mm
长度: 总长减 30mm

TQW-250

十六孔铝合金透气网 (25cm 宽)
Sixteen hole aluminum alloy breathable mesh (25cm wide)

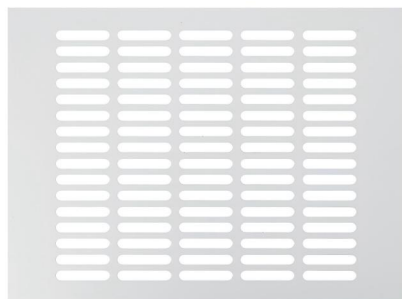

开孔尺寸
宽度: 231mm
长度: 总长减 30mm

TQW-300

二十孔铝合金透气网 (30cm 宽)
Twenty hole aluminum alloy breathable mesh (30cm wide)

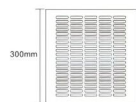
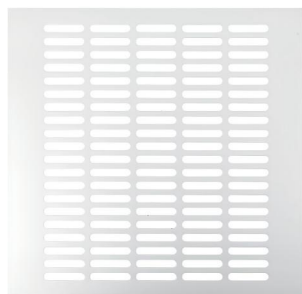

开孔尺寸
宽度: 281mm
长度: 总长减 30mm

TQW-60C

错位孔铝合金透气网 (6cm 宽)
Aluminum alloy mesh with staggered holes (6cm wide)

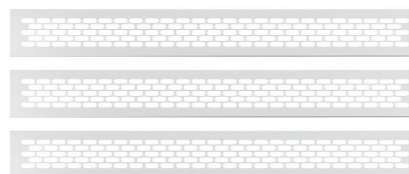

开孔尺寸
宽度: 46mm
长度: 总长减 30mm

TQW-80C

错位孔铝合金透气网 (8cm 宽)
Alloy air mesh with misplaced holes (8cm wide)

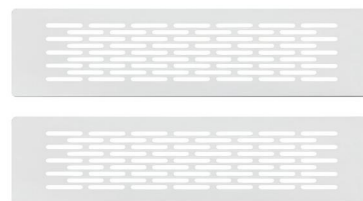

开孔尺寸
宽度: 64mm
长度: 总长减 30mm

Breathable Mesh Series
透气网系列

TQW-80XYK

小圆孔铝合金透气网 (8cm 宽)
Small round hole aluminum alloy breathable mesh (8cm wide)

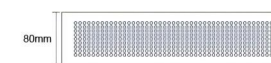
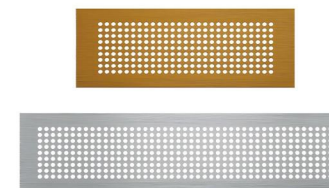

开孔尺寸
宽度: 64mm
长度: 总长减 30mm

TQW-80W

花式铝合金透气网 (8cm 宽)
Fancy aluminum alloy breathable mesh (8cm wide)

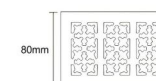
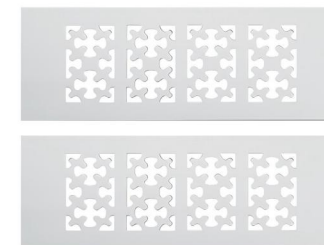

开孔尺寸
宽度: 64mm
长度: 总长减 30mm

Breathable Mesh Series
透气网系列

F Type Adjustable Glass Clip Series
F 型可调玻璃夹系列

TQW-80LFCX

龙凤呈祥透气网 (8cm 宽)
Dragon and Phoenix Breathable Mesh (8cm wide)
专利号: ZL 2021 3 0858968.9



开孔尺寸
宽度: 64mm
长度: 总长减 30mm

TQW-80FQLM

福气临门透气网 (8cm 宽)
Fufulinmen breathable mesh (8cm wide)



开孔尺寸
宽度: 64mm
长度: 总长减 30mm

TQW-80SC

内外面双层透气网 (8cm 宽)
Inner and outer double layer breathable mesh (8cm wide)
专利号: ZL 2021 3 0809236.0
ZL 2021 2 3061341.4

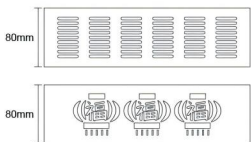

开孔尺寸
宽度: 68mm
长度: 总长减 30mm

TQW-100W

花式铝合金透气网 (10cm 宽)
Fancy aluminum alloy ventilation mesh (10cm wide)

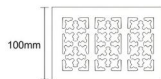
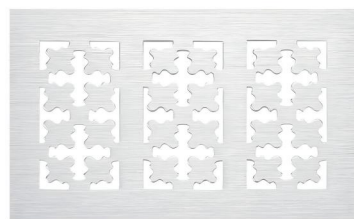

开孔尺寸
宽度: 88mm
长度: 总长减 30mm



BLJ-FA

大号 F 型可调夹
Large f-type adjustable clamp

- A 材质: 锌合金
Material: zinc alloy
- B 表面处理: 光铬、拉丝镍、仿金、珍珠铬、珍珠镍、红古铜、青古铜、枪黑、喷漆
Finish: chrome, brush nickel, golden, matt chrome, peal nickel, bronze, green bronze, lance black, spray
- C 玻璃厚度: 3-40mm, 大号
Glass thickness: 3-40mm, large
- D 适用范围: 玻璃层板、木层板
Available For: glass shelf and wooden plywood

详细参数
Detailed Parameter

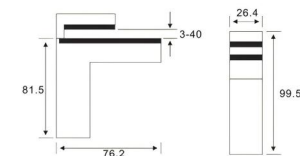

BLJ-FB

中号 F 型可调夹
Medium f-type adjustable clamp

- A 材质: 锌合金
Material: zinc alloy
- B 表面处理: 光铬、拉丝镍、仿金、珍珠铬、珍珠镍、红古铜、青古铜、枪黑、喷漆
Finish: chrome, brush nickel, golden, matt chrome, peal nickel, bronze, green bronze, lance black, spray
- C 玻璃厚度: 3-30mm, 中号
Glass thickness: 3-30mm, medium
- D 适用范围: 玻璃层板、木层板
Available For: glass shelf and wooden plywood

详细参数
Detailed Parameter

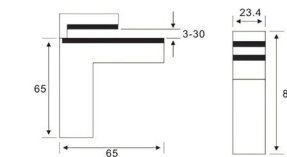

BLJ-FC

小号 F 型可调夹
Small F-type adjustable clip

- A 材质: 锌合金
Material: zinc alloy
- B 表面处理: 光铬、拉丝镍、仿金、珍珠铬、珍珠镍、红古铜、青古铜、枪黑、喷漆
Finish: chrome, brush nickel, golden, matt chrome, peal nickel, bronze, green bronze, lance black, spray
- C 玻璃厚度: 5-20mm, 小号
Glass thickness: 5-20mm, small size
- D 适用范围: 玻璃层板、木层板
Available For: glass shelf and wooden plywood

详细参数
Detailed Parameter

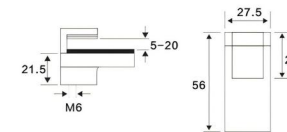

BLJ-FD

微小号 F 型可调夹
Small size F-type adjustable clip

- A 材质: 锌合金
Material: zinc alloy
- B 表面处理: 光铬、拉丝镍、仿金、珍珠铬、珍珠镍、红古铜、青古铜、枪黑、喷漆
Finish: chrome, brush nickel, golden, matt chrome, peal nickel, bronze, green bronze, lance black, spray
- C 玻璃厚度: 5-15mm, 微小号
Glass thickness: 5-15mm, micro size
- D 适用范围: 玻璃层板、木层板
Available For: glass shelf and wooden plywood

详细参数
Detailed Parameter

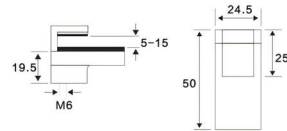

Olecranon Adjustable Glass Clamp Series

鹰嘴型可调玻璃夹系列

Fish Mouth Type Adjustable Glass Clip Series

鱼嘴型可调玻璃夹系列



BLJ-YA

大号鹰嘴可调夹

Large olecranon adjustable clip

- A** 材质：锌合金
Material: zinc alloy
- B** 表面处理：光铬、拉丝镍、仿金、珍珠铬、珍珠镍、红古铜、青古铜、枪黑、喷漆
Finish: chrome, brush nickel, golden, matt chrome, peal nickel, bronze, green bronze, lance black, spray
- C** 玻璃厚度：5-30mm, 大号
Glass thickness: 5-30mm, large
- D** 适用范围：玻璃层板、木层板
Available For: glass shelf and wooden plywood

详细参数
Detailed Parameter

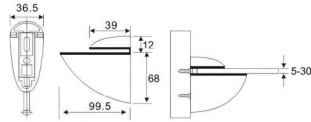

BLJ-YJA

鱼嘴可调夹

Fish mouth adjustable clip

- A** 材质：锌合金
Material: zinc alloy
- B** 表面处理：光铬、拉丝镍、仿金、珍珠铬、珍珠镍、红古铜、青古铜、枪黑、喷漆
Finish: chrome, brush nickel, golden, matt chrome, peal nickel, bronze, green bronze, lance black, spray
- C** 玻璃厚度：6-40mm, 大号
Glass thickness: 6-40mm, large
- D** 适用范围：玻璃层板、木层板
Available For: glass shelf and wooden plywood

详细参数
Detailed Parameter

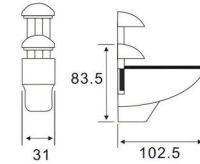

BLJ-YB

中号鹰嘴可调夹

Medium olecranon adjustable clip

- A** 材质：锌合金
Material: zinc alloy
- B** 表面处理：光铬、拉丝镍、仿金、珍珠铬、珍珠镍、红古铜、青古铜、枪黑、喷漆
Finish: chrome, brush nickel, golden, matt chrome, peal nickel, bronze, green bronze, lance black, spray
- C** 玻璃厚度：5-20mm, 中号
Glass thickness: 5-20mm, medium
- D** 适用范围：玻璃层板、木层板
Available For: glass shelf and wooden plywood

详细参数
Detailed Parameter

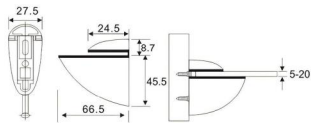

BLJ-YJB

鱼嘴可调夹

Fish mouth adjustable clip

- A** 材质：锌合金
Material: zinc alloy
- B** 表面处理：光铬、拉丝镍、仿金、珍珠铬、珍珠镍、红古铜、青古铜、枪黑、喷漆
Finish: chrome, brush nickel, golden, matt chrome, peal nickel, bronze, green bronze, lance black, spray
- C** 玻璃厚度：6-25mm, 中号
Glass thickness: 6-25mm, medium
- D** 适用范围：玻璃层板、木层板
Available For: glass shelf and wooden plywood

详细参数
Detailed Parameter

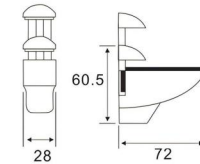

BLJ-YC

小号鹰嘴可调夹

Small olecranon adjustable clip

- A** 材质：锌合金
Material: zinc alloy
- B** 表面处理：光铬、拉丝镍、仿金、珍珠铬、珍珠镍、红古铜、青古铜、枪黑、喷漆
Finish: chrome, brush nickel, golden, matt chrome, peal nickel, bronze, green bronze, lance black, spray
- C** 玻璃厚度：5-15mm, 小号
Glass thickness: 5-15mm, small size
- D** 适用范围：玻璃层板、木层板
Available For: glass shelf and wooden plywood

详细参数
Detailed Parameter

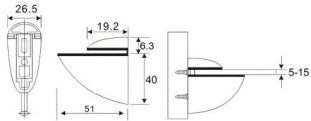

BLJ-YJC

鱼嘴可调夹

Fish mouth adjustable clip

- A** 材质：锌合金
Material: zinc alloy
- B** 表面处理：光铬、拉丝镍、仿金、珍珠铬、珍珠镍、红古铜、青古铜、枪黑、喷漆
Finish: chrome, brush nickel, golden, matt chrome, peal nickel, bronze, green bronze, lance black, spray
- C** 玻璃厚度：3-20mm, 小号
Glass thickness: 3-20mm, small size
- D** 适用范围：玻璃层板、木层板
Available For: glass shelf and wooden plywood

详细参数
Detailed Parameter

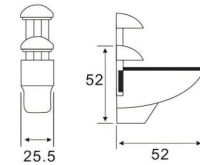

BLJ-YD

微小号鹰嘴可调夹

Small size olecranon adjustable clip

- A** 材质：锌合金
Material: zinc alloy
- B** 表面处理：光铬、拉丝镍、仿金、珍珠铬、珍珠镍、红古铜、青古铜、枪黑、喷漆
Finish: chrome, brush nickel, golden, matt chrome, peal nickel, bronze, green bronze, lance black, spray
- C** 玻璃厚度：5-10mm, 微小号
Glass thickness: 5-10mm, micro size
- D** 适用范围：玻璃层板、木层板
Available For: glass shelf and wooden plywood

详细参数
Detailed Parameter

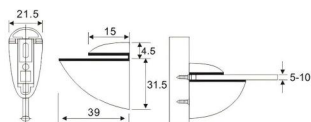

BLJ-YPJ

平嘴可调夹

Flat mouth adjustable clamp

- A** 材质：锌合金
Material: zinc alloy
- B** 表面处理：光铬、拉丝镍、仿金、珍珠铬、珍珠镍、红古铜、青古铜、枪黑、喷漆
Finish: chrome, brush nickel, golden, matt chrome, peal nickel, bronze, green bronze, lance black, spray
- C** 玻璃厚度：5-20mm
Glass thickness: 5-20mm
- D** 适用范围：玻璃层板、木层板
Available For: glass shelf and wooden plywood

详细参数
Detailed Parameter

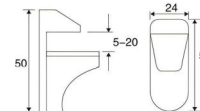

Movable Glass Clip Series

活动玻璃夹系列

Fixed Glass Clip Series

固定玻璃夹系列

a 材质: 锌合金
Material: zinc alloy

b 表面处理: 光铬、拉丝镍、仿金、珍珠镍、珍珠镍、红古铜、青古铜、枪黑、喷漆
Finish: chrome, brush nickel, golden, matt chrome, pearl nickel, bronze, green bronze, lance black, spray

c 适用范围: 玻璃层板
Available For: glass shelf

a 材质: 锌合金
Material: zinc alloy

b 表面处理: 光铬、拉丝镍、仿金、珍珠镍、珍珠镍、红古铜、青古铜、枪黑、喷漆
Finish: chrome, brush nickel, golden, matt chrome, pearl nickel, bronze, green bronze, lance black, spray

c 适用范围: 玻璃层板、木板
Available For: glass shelf and wooden plywood

BLJ-81A

活动玻璃夹
Movable glass clamp

弧底
Around Bottom
玻璃厚度: 6-8mm
Glass thickness: 6-8mm

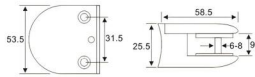

BLJ-81B

活动玻璃夹
Movable glass clamp

平底
Flat bottom
玻璃厚度: 6-8mm
Glass thickness: 6-8mm

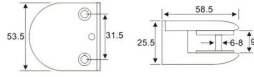

BLJ-82A

活动玻璃夹
Movable glass clamp

弧底
Around Bottom
玻璃厚度: 8-10mm
Glass thickness: 8-10mm



BLJ-82B

活动玻璃夹
Movable glass clamp

平底
Flat bottom
玻璃厚度: 8-10mm
Glass thickness: 8-10mm



BLJ-83A

活动玻璃夹
Movable glass clamp

弧底
Around Bottom
玻璃厚度: 10-12mm
Glass thickness: 10-12mm



BLJ-83B

活动玻璃夹
Movable glass clamp

平底
Flat bottom
玻璃厚度: 10-12mm
Glass thickness: 10-12mm

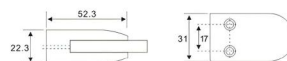

BLJ-01

玻璃厚度: 8mm
Glass thickness: 8mm

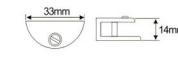

BLJ-02

玻璃厚度: 10mm
Glass thickness: 10mm

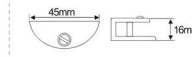

BLJ-03

玻璃厚度: 12mm
Glass thickness: 12mm

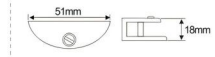

BLJ-04

玻璃厚度: 6-8mm
Glass thickness: 6-8mm

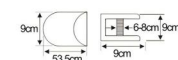

BLJ-05

玻璃厚度: 8-10mm
Glass thickness: 8-10mm

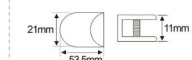

BLJ-06

玻璃厚度: 10-12mm
Glass thickness: 10-12mm

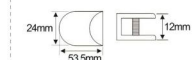

BLJ-07

玻璃厚度: 10mm
Glass thickness: 10mm

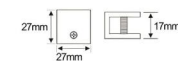

BLJ-08

玻璃厚度: 12mm
Glass thickness: 12mm

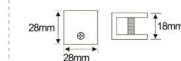

BLJ-09

玻璃厚度: 10mm
Glass thickness: 10mm

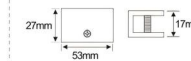

BLJ-10

玻璃厚度: 12mm
Glass thickness: 12mm

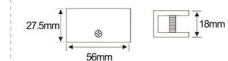

Zinc Alloy Laminate Support, Clothing Support Series

锌合金层板托、衣托系列

Zinc Alloy Flange, Clothes Pipe Seat Series

锌合金法兰、衣管座系列

RMR-81

实心托 C 型
Solid bracket type C

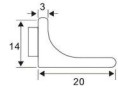

RMR-82

实心托 B 型
Solid bracket type B

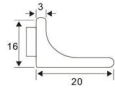

RMR-83

实心托 A 型
Solid support type A

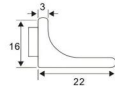

RMR-84

大直角托
Large Right Angle Holder

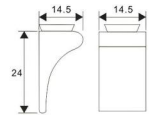

RMR-85

心形托
Heart shaped holder

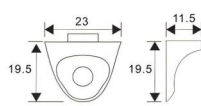

RMR-101

二孔衣托
Two-hole garment tray

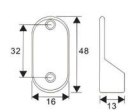

RMR-102

三孔衣托
Three-hole garment tray

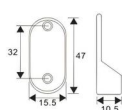

RMR-103

左右托
left and right support

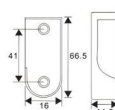

RMR-104

长衣托
coat holder

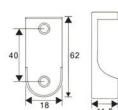

RMR-105

带盖衣托
with cover

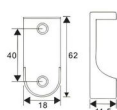

RMR-106

小号暗藏衣托
Small hidden clothes holder

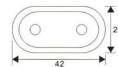

RMR-107

中号暗藏衣托
Medium hidden clothes holder

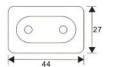

RMR-108

大号暗藏衣托
Large hidden clothes holder

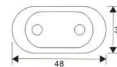

RMR-109

分体暗藏衣托
Split hidden clothes holder

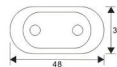

RMR-111

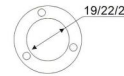

RMR-112

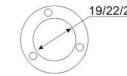

RMR-113

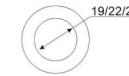

RMR-114

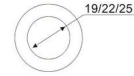

RMR-115

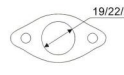

RMR-116

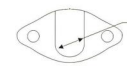

RMR-117

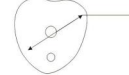

RMR-118

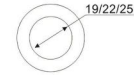

RMR-121

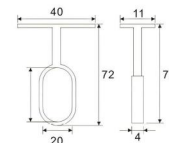

RMR-122

Φ 19/22/25



RMR-123

Φ 19/22/25



RMR-131



RMR-132



RMR-133

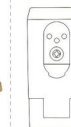

Buffer, Bouncer Series

缓冲器、反弹器系列

Telescopic Hanger Series

伸缩衣架系列

RMR-161

缓冲芯
材质:ABS
Material:ABS



RMR-162

缓冲后机翼
材质:ABS
Material:ABS



RMR-163

缓冲前机翼
材质:ABS
Material:ABS



RMR-164

缓冲暗藏
材质:ABS
Material:ABS



RMR-165

小号无翼带磁反弹器(底装)
材质:POM
Material:POM



RMR-166

小号无翼反弹器(底装)
材质:POM
Material:POM



RMR-167

大号无翼带磁反弹器(底装)
材质:POM
Material:POM



RMR-168

大号无翼反弹器(底装)
材质:POM
Material:POM



RMR-169

小号有翼带磁反弹器(侧装)
材质:POM
Material:POM



RMR-170

小号有翼反弹器(侧装)
材质:POM
Material:POM



RMR-171

大号有翼带磁反弹器(侧装)
材质:POM
Material:POM



RMR-172

大号有翼反弹器(侧装)
材质:POM
Material:POM



RMR-175

不锈钢带磁反弹器



RMR-176

铝壳带磁反弹器(底装)



RMR-177

铝壳带磁反弹器(侧装)



RMR-178

双头铝壳带磁反弹器(侧装)



SSYJ-01A

极简快装正方形钢管 A 款
Minimalist quick loading square steel pipe type A



SSYJ-01B

极简快装正方形钢管 B 款
Minimalist quick loading square steel pipe type B



SSYJ-01C

极简快装椭圆形钢管不带珠款
Minimalist quick loading oval steel pipe without beads



SSYJ-01D

极简快装椭圆形钢管带珠款
Minimalist quick loading oval steel pipe with beads



SSYJ-02A

快装带珠款
Quick loading with beads



SSYJ-02B

快装不带珠款(实心管)
Quick loading without beads (solid tube)



Telescopic Hanger Series
伸缩衣架系列

Telescopic Hanger Series
伸缩衣架系列

SSYJ-02C

快装不带珠款 (空心管)
Quick loading without beads (hollow tube)



SSYJ-03A

单两节轨直角形钢管带珠款
Single two-section rail right angle steel pipe with beads



SSYJ-04C

单三节轨直线钢管带珠款
Single three-section rail straight steel pipe with beads



SSYJ-04D

单三节轨直线圆铝管不带珠款
Single three-section rail straight line round aluminum tube without beads



SSYJ-03B

单三节轨直角形钢管带珠款
Single three-section rail right-angle steel pipe with beads



SSYJ-03C

单三节轨直角形扁铝管带珠款
Single three-section rail right-angle flat aluminum tube with beads



SSYJ-21A

可调挂衣杆 A 款 (不锈钢款 / 铁料款)
Adjustable clothes rail type A (stainless steel type/iron material type)



SSYJ-21B

可调挂衣杆 B 款
Adjustable clothes rail type B



SSYJ-04A

单两节轨直线钢管带珠款
Single two-section rail straight steel pipe with beads



SSYJ-04B

单两节轨直线椭圆铝管不带珠款
Single two-section rail straight oval aluminum tube without beads



SSYJ-21C

可调挂衣杆 C 款
Adjustable clothes rail type C



SSYJ-31

极简铝衣钩
Minimalist aluminum coat hook



Folding, Functional Accessories Series

折叠、功能配件系列

ZDJ-001

上翻折叠桌配件
Flip-Up Table Accessories



ZDJ-002

下翻折叠桌配件 (铝)
Flip down folding table accessories (aluminum)



ZDJ-003

折叠桌配件 (下翻板)
Folding table accessories (lower flap)



Product Catalog

Folding, Functional Accessories Series

折叠、功能配件系列

ZDJ-004

平推折叠桌配件 (不带柜)
Flat push folding table accessories (without cabinet)

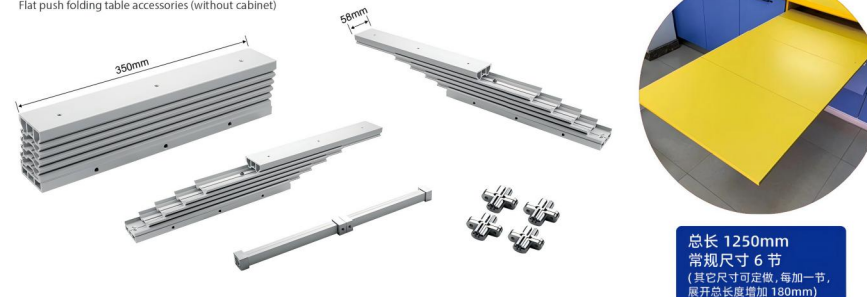

ZDJ-005

平推折叠桌配件 (带柜)
Flat push folding table accessories (with cabinet)

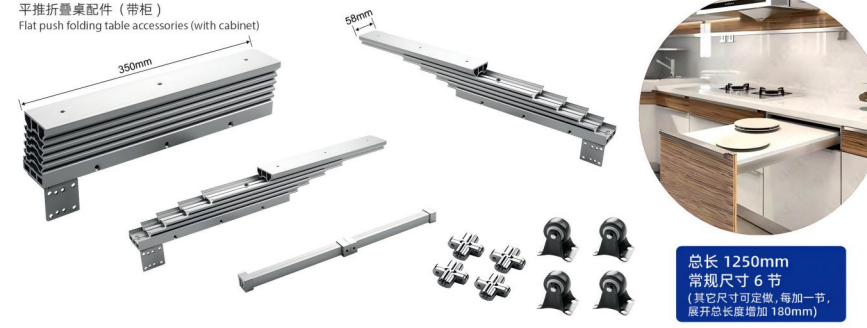

ZDJ-006

平推折叠桌配件 (下翻板)
Flat push folding table accessories (lower flap)

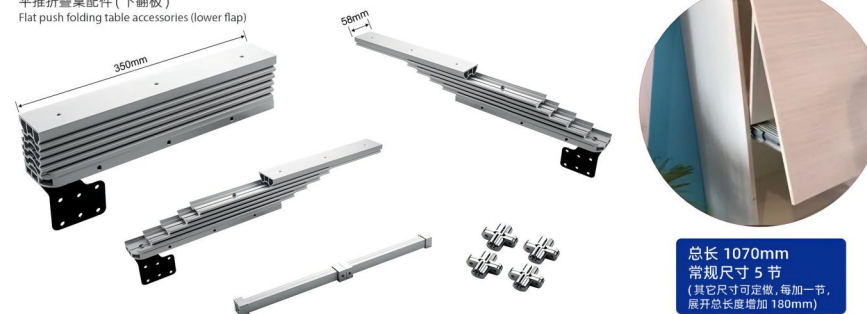

RUICHENG 023 / 024

Folding, Functional Accessories Series

折叠、功能配件系列

ZDJ-007A

平推折叠桌配件 (带单脚)
Flat push folding table accessories (with single leg)



ZDJ-007B

平推折叠桌配件 (带双脚)
Flat push folding table accessories (with feet)

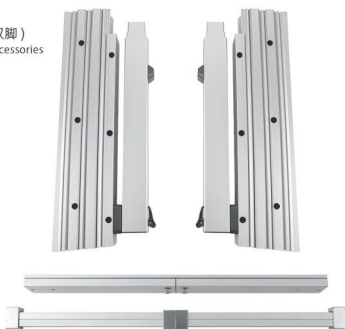

总长 1900mm
常规尺寸 6 节
(其它尺寸可定做)

ZDJ-007C

平推折叠桌配件 (中间带脚)
Flat push folding table accessories (with legs in the middle)

专利号: ZL 2021 2 3061327.4



常规尺寸

节数	收合长度	展开总长	桌面总长
6 节	460mm	1960mm	2000mm
7 节	460mm	2260mm	2300mm
8 节	460mm	2560mm	2600mm

Product Catalog

Folding, Functional Accessories Series

折叠、功能配件系列

ZDJ-008

双向缓冲折叠凳配件
Two-way cushioning folding stool accessories

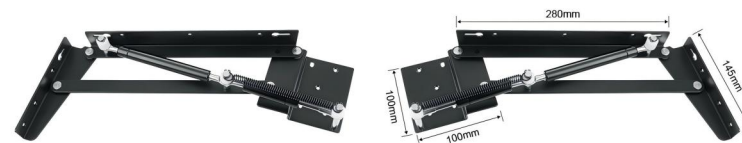

ZDJ-009

上缓冲折叠凳配件
Upper buffer folding stool accessories



ZDJ-011A

下缓冲折叠凳配件 A 款
Lower buffer folding stool accessories type A

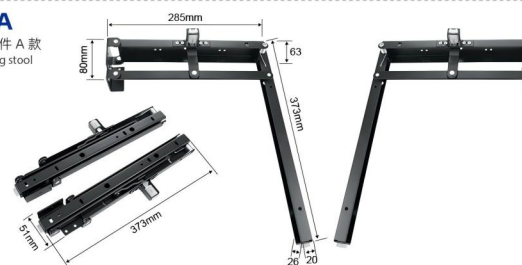

ZDJ-011B

下缓冲折叠凳配件 B 款
Lower buffer folding stool accessories type B



RUICHENG 025 / 026

Folding, Functional Accessories Series

折叠、功能配件系列

ZDJ-012

成品折叠凳 (带扶手)
Finished folding stool (with armrests)

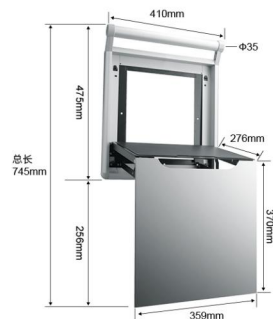

多种颜色可供选择

ZDJ-013

成品折叠凳 (不带扶手)
Finished folding stool (without armrest)

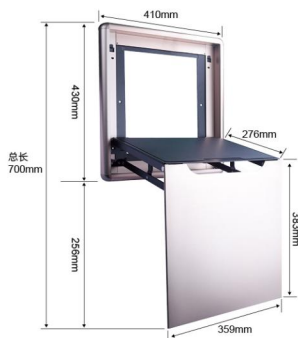
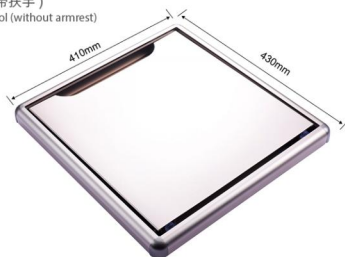

多种颜色可供选择

ZDJ-014

成品折叠凳 (木质)
Finished folding stool (wooden)

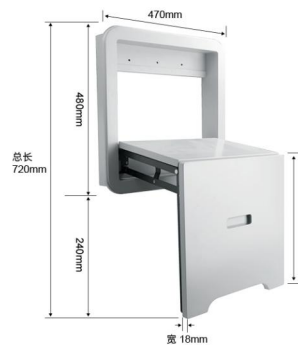

多种颜色可供选择

Folding, Functional Accessories Series

折叠、功能配件系列

XZZDZ-01

旋转折叠桌配件
Rotating Folding Table Accessories



XZZDZ-02

旋转折叠桌配件 (简易安装款)
Rotating folding table accessories (easy installation)



XZZDZ-06

360度旋转柜配件
360 degree rotating cabinet accessories



Folding, Functional Accessories Series

折叠、功能配件系列

XZZ-001

平移旋转桌配件
Pan and Rotate Table Accessories

专利号: ZL 2021 2 3061334.4



平移款
平移旋转款

规格	2000/3000-600/800MM	Specification	2000/3000-600/800MM
材质	铝合金	Material	Aluminum alloy
承重	70KG	Loading capacity	70KG

GBYXZ-01

挂壁隐形桌配件
Wall-mounted invisible table accessories

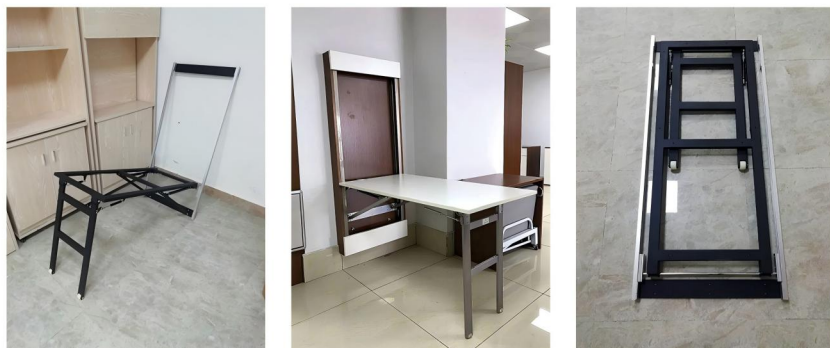

面板尺寸	1380x780x25mm
装饰尺寸	780x160x25mm
铝框尺寸	1452x796x62mm

Folding, Functional Accessories Series

折叠、功能配件系列

BXJG-01

变形金刚
Transformers

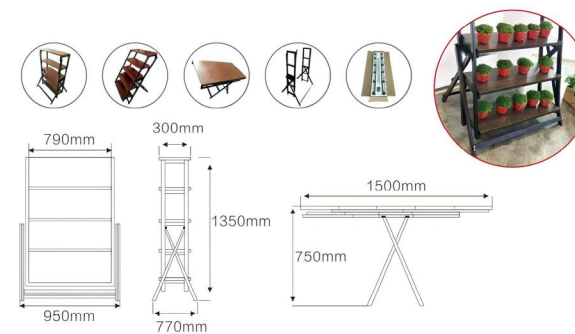

BXJG-02

挂壁式变形金刚 (蜘蛛侠)
Wall-mounted Transformers (Spiderman)



Folding, Functional Accessories Series

折叠、功能配件系列

CJJ-001

气撑茶几铰
Air support coffee table hinge



CJJ-002

弹簧茶几铰
Spring coffee table hinge

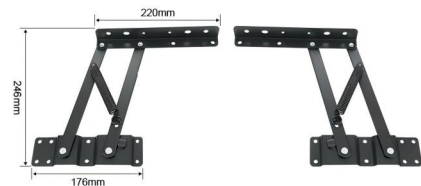

CJJ-003

气撑茶几铰
Air support coffee table hinge

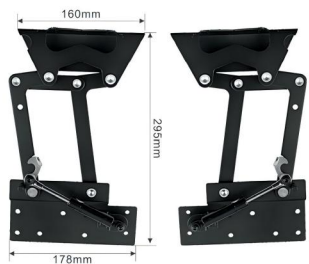

CJJ-004

分体沙发头枕铰
Split sofa headrest hinge



CJJ-005

连体沙发头枕铰
One piece sofa headrest hinge



CJJ-010

大型茶几铰
large coffee table hinge



规格	备注
450	气撑 / 弹簧
560	气撑 / 弹簧
660	气撑 / 弹簧



QDYXC-01A

气动正翻隐形床架 (前脚)
Pneumatic forward turning invisible bed frame (front foot)



QDYXC-02A

气动侧翻隐形床架 (前脚)
Pneumatic rollover invisible bed frame (front foot)



Invisible Bed Series

隐形床系列

床垫规格
Mattress Specifications

<p>350 1020 自动脚正翻1.0*2.0米 适合单人或儿童榻</p> <p>内宽970 内宽2030</p> <p>床垫0.9*2.0 厚度不超过20cm 重量≤11kg</p> <p>2140 170</p> <p>翻动过程空间需要2220mm</p> <p>五金配件 (不包床箱和床垫)</p>	<p>350 1320 自动脚正翻1.2*2.0米 适合两个年轻人榻</p> <p>内宽1270 内宽2030</p> <p>床垫1.2*2.0 厚度不超过20cm 重量≤11kg</p> <p>2140 170</p> <p>翻动过程空间需要2220mm</p> <p>五金配件 (不包床箱和床垫)</p>
<p>350 1620 自动脚正翻1.5*2.0米 适合双人榻</p> <p>内宽1570 内宽2030</p> <p>床垫1.5*2.0 厚度不超过20cm 重量≤11kg</p> <p>2140 170</p> <p>翻动过程空间需要2220mm</p> <p>五金配件 (不包床箱和床垫)</p>	<p>350 1920 自动脚正翻1.8*2.0米 超大双人榻</p> <p>内宽1870 内宽2030</p> <p>床垫1.8*2.0 厚度不超过20cm 重量≤11kg</p> <p>2140 170</p> <p>翻动过程空间需要2220mm</p> <p>五金配件 (不包床箱和床垫)</p>

床垫规格
Mattress Specifications

<p>自动脚侧翻1.0*2.0米 适合单人或儿童榻</p> <p>350 2120</p> <p>980</p> <p>150 1040</p> <p>翻动过程空间需要1180mm</p> <p>五金配件 (不包床箱和床垫)</p>	<p>自动脚侧翻1.2*2.0米 适合两个年轻人榻</p> <p>350 2120</p> <p>1280</p> <p>170 1140</p> <p>翻动过程空间需要1460mm</p> <p>五金配件 (不包床箱和床垫)</p>
<p>自动脚侧翻1.5*2.0米 适合双人榻</p> <p>350 2120</p> <p>1580</p> <p>170 1140</p> <p>翻动过程空间需要1740mm</p> <p>五金配件 (不包床箱和床垫)</p>	<p>自动脚侧翻1.8*2.0米 超大双人榻</p> <p>350 2120</p> <p>1880</p> <p>170 1140</p> <p>翻动过程空间需要2030mm</p> <p>五金配件 (不包床箱和床垫)</p>

SYT-51

电动上翻折叠双门板支撑
Electric flip-up folding double door panel support



SYT-52

电动上翻开门支撑
Electric swing up swing door support



SYT-53

电动上翻平移门支撑
Electric upturn sliding door support



SYT-54

电动上翻斜移门支撑
Electric up tilt sliding door support



	Cabinet width(mm) 柜体宽度 (mm)	Cabinet height(mm) 柜体高度 (mm)	Cabinet Depth(mm) 柜体深度 (mm)	Cabinet door weight(KG) 柜门重量 (KG)
Electric up-folding door support 电动上翻折叠门支撑	300-1000	600-740	>300	轻型: 3-5KG 中型: 5-7KG 重型: 7-9KG
Electric swing up swing door support 电动上翻开门支撑	300-1000	330-500	>300	轻型: 3-5.5KG 中型: 5.5-9KG 重型: 8-9KG
Electric upturn sliding door support 电动上翻平移门支撑	300-1000	440-1000	>300	轻型: 3-4KG 中型: 4-6KG 重型: 5-9KG
Electric up tilt sliding door support 电动上翻斜移门支撑	300-1000	390-1000	>300	轻型: 3-5KG 中型: 5-6KG 重型: 5-9KG

LS-01C 榻榻米拉手

- a 材质: 锌合金
Material: zinc alloy
- b 表面处理: 亮光 / 拉丝 / 玫瑰金 / 红古铜 / 青古铜 / 金色
Finish: Bright/brushed/rose gold/red bronze/green bronze/gold
- c 开孔尺寸: 68.5x12mm
Hole size: 68.5x12mm



LS-01B 榻榻米拉手

- a 材质: 锌合金
Material: zinc alloy
- b 表面处理: 亮光 / 拉丝 / 玫瑰金 / 红古铜 / 青古铜 / 金色
Finish: Bright/brushed/rose gold/red bronze/green bronze/gold
- c 开孔尺寸: 92x16mm
Hole size: 92x16mm



LS-01A 榻榻米拉手

- a 材质: 锌合金
Material: zinc alloy
- b 表面处理: 亮光 / 拉丝 / 玫瑰金 / 红古铜 / 青古铜 / 金色
Finish: Bright/brushed/rose gold/red bronze/green bronze/gold



LS-02 按键拉手

- a 材质: 锌合金、塑料
Material: zinc alloy, plastic
- b 表面处理: 亮光 / 拉丝 / 玫瑰金 / 红古铜 / 青古铜 / 金色
Finish: Bright/brushed/rose gold/red bronze/green bronze/gold



LS-04 榻榻米拉手

- a 材质: 锌合金
Material: zinc alloy
- b 表面处理: 亮光 / 拉丝 / 玫瑰金 / 红古铜 / 青古铜 / 金色
Finish: Bright/brushed/rose gold/red bronze/green bronze/gold
- c 开孔尺寸: 92x16mm
Hole size: 92x16mm



LS-03A LS-03B 圆形拉手

- a 材质: 锌合金
Material: zinc alloy
- b 表面处理: 亮光 / 拉丝 / 玫瑰金 / 红古铜 / 青古铜 / 金色
Finish: Bright/brushed/rose gold/red bronze/green bronze/gold
- c 开孔尺寸: 68.5x12mm
Hole size: 68.5x12mm

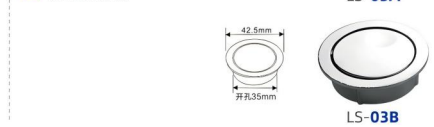

ZC-01 榻榻米支撑

- a 材质: 钢材
Material: steel
- b 表面处理: 亮光
Finish: Bright



力度选择: 60N/80N/100N/120N/150N
效果选择: 缓冲 / 静音停 180N/200N

ZC-02 小金刚支撑

- a 材质: 不锈钢
Material: Stainless steel
- b 表面处理: 亮光 / 拉丝
Finish: Bright/brushed



力度选择: 60N/80N/100N/120N/150N

Tatami Lift Series
榻榻米升降机系列

DDTTM-02 电动式榻榻米升降机 (24 伏电压)
Electric tatami lift



升降节数 3 节
降到最矮 310mm
升到最高 680mm

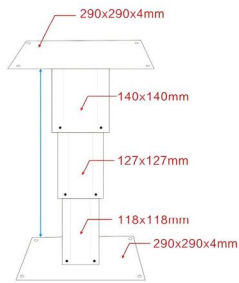

常规高度	行程
310-665	355
360-800	440

(单位: 毫米)



- ① 面板尺寸 290x290x4mm
- ② 高度 :310-665mm, 可按需求订做
- ③ 行程 :355mm, 可按需求订做
- ④ 可调节数 : 三节
- ⑤ 表面处理 : 哑光、黑色、拉丝、木纹、金色等
- ⑥ 备注 : 本品牌比其它厂家铝管铝壁更厚, 铝材强度更高, 铝材材质更好, 采用高强度太空铝精加工, 升降高度更高

Tatami Lift Series
榻榻米升降机系列

QDTTM-01 气动式榻榻米升降机 两节
Pneumatic Tatami Lift



常规高度	行程
410-700	290
360-600	240

(单位: 毫米)



未升高

- ① 面板尺寸 290x290x4mm
- ② 高度 :410-700mm(不含控制开关), 可按需求订做
- ③ 行程 :290mm, 可按需求订做
- ④ 可调节数 : 两节
- ⑤ 表面处理 : 哑光、黑色、拉丝、木纹、金色等

⑥ 备注 1: 本产品采用后控气撑结构, 大大提高产品的稳定性和安全性

备注 2: 独特式控制开关有别于其它品牌, 方便、省力、安全、易用

备注 3: 本品牌比其它厂家铝管铝壁更厚, 铝材强度更高, 铝材材质更好, 采用高强度太空铝精加工, 升降高度更高

SDDTTM-06 双头电动式榻榻米升降机
Double head electric tatami lift



常规高度	行程
310-680	370
360-820	460

(单位: 毫米)

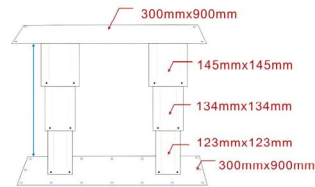

- ① 面板尺寸 300x900x4.5mm
- ② 高度 :310-680mm, 可按需求订做
- ③ 行程 :370mm, 可按需求订做
- ④ 可调节数 : 三节
- ⑤ 表面处理 : 哑光、黑色、拉丝、木纹、金色等
- ⑥ 备注 : 本品牌比其它厂家铝管铝壁更厚, 铝材强度更高, 铝材材质更好, 采用高强度太空铝精加工, 升降高度更高

未升高

CZQDTTM-01 气动式榻榻米升降机 两节
Pneumatic Tatami Lift



常规高度	行程
410-700	290
360-600	240

(单位: 毫米)



未升高

- ① 面板尺寸 290x290x4mm
- ② 高度 :410-700mm(不含控制开关), 可按需求订做
- ③ 行程 :290mm, 可按需求订做
- ④ 可调节数 : 两节
- ⑤ 表面处理 : 哑光、黑色、拉丝、木纹、金色等

⑥ 备注 3: 本品牌比其它厂家铝管铝壁更厚, 铝材强度更高, 铝材材质更好, 采用高强度太空铝精加工, 升降高度更高

Tatami Lift Series
榻榻米升降机系列

Tatami Lift Series
榻榻米升降机系列

CZQDTTM-02 气动式榻榻米升降机 三节
Pneumatic Tatami Lift

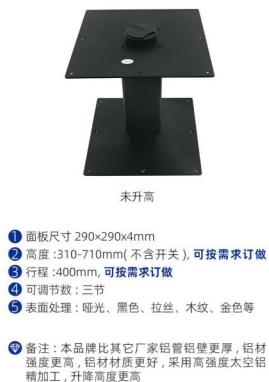

SDTTM-02 手动式榻榻米升降机 (中铝)
Manual tatami lift (medium aluminum)

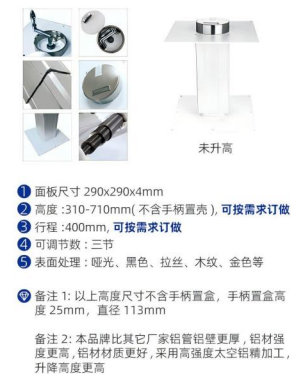

SDTTM-01 手动式榻榻米升降机 (大铝)
Manual tatami lift (big aluminum)



SDTTM-03 手动式榻榻米升降机 (小铝)
Manual tatami lift (small aluminum)

